

Barton

Living

6FT METAL CHRISTMAS TREE STAND

ITEM # 96814 (BLACK) 96815 (GOLD)

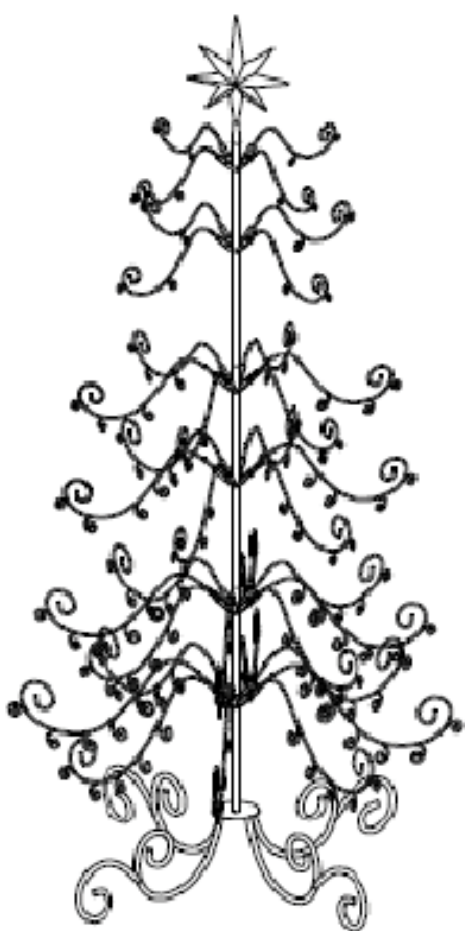

OWNER'S MANUAL AND SAFETY INSTRUCTIONS

SAVE THIS MANUAL. KEEP THIS MANUAL FOR SAFETY WARNINGS, PRECAUTIONS, ASSEMBLY, OPERATION, INSPECTION, MAINTENANCE AND CLEANING PROCEDURES. WRITE THE PRODUCT'S SERIAL NUMBER ON THE BACK OF THE MANUAL, OR THE MONTH AND YEAR OF PURCHASE IF PRODUCT HAS NO SERIAL NUMBER

FOR QUESTIONS, PLEASE CALL CUSTOMER SERVICE: 909.628.4900

PARTS INFORMATION

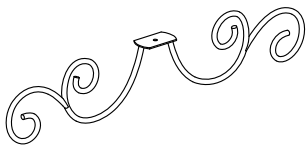
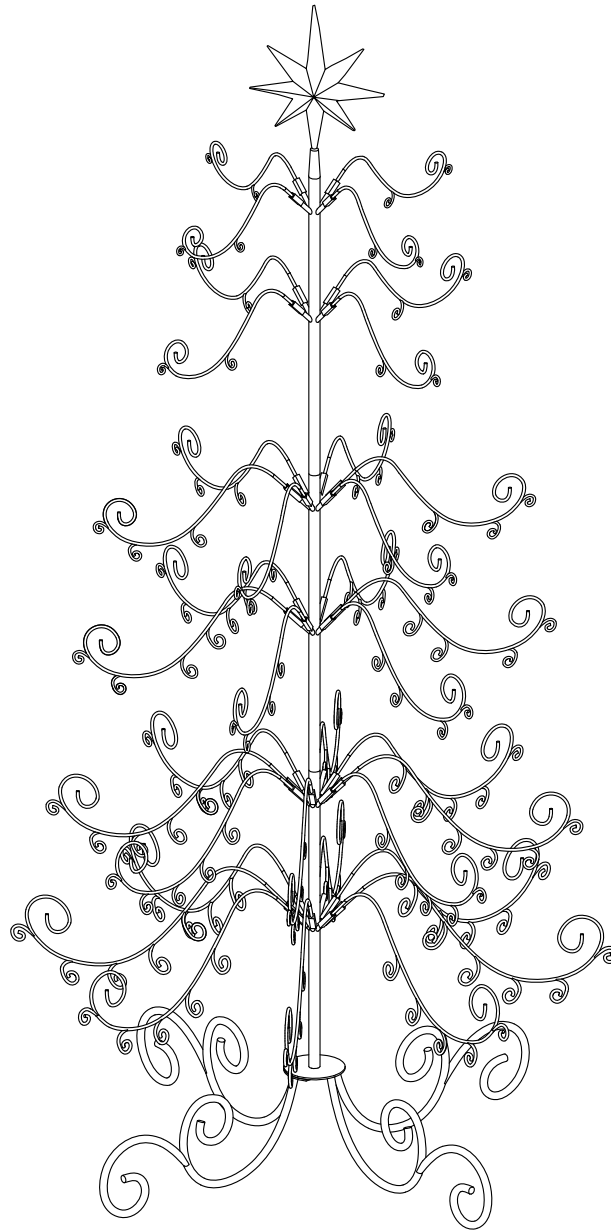

A×1PC

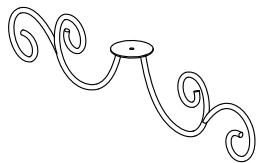

B×1PC

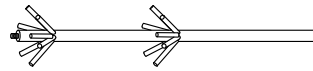

C×1PC

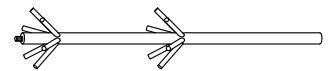

D×1PC

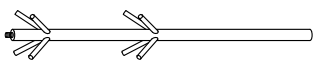

E×1PC

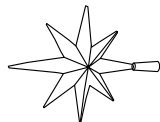

F×1PC



G×4PCS



H×4PCS



I×6PCS



J×6PCS

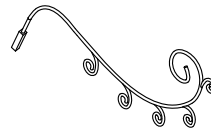

K×8PCS

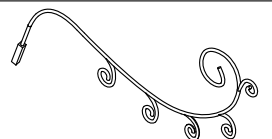

L×8PCS

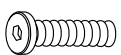

M×1PC



N×1PC

ASSEMBLY

Step 1

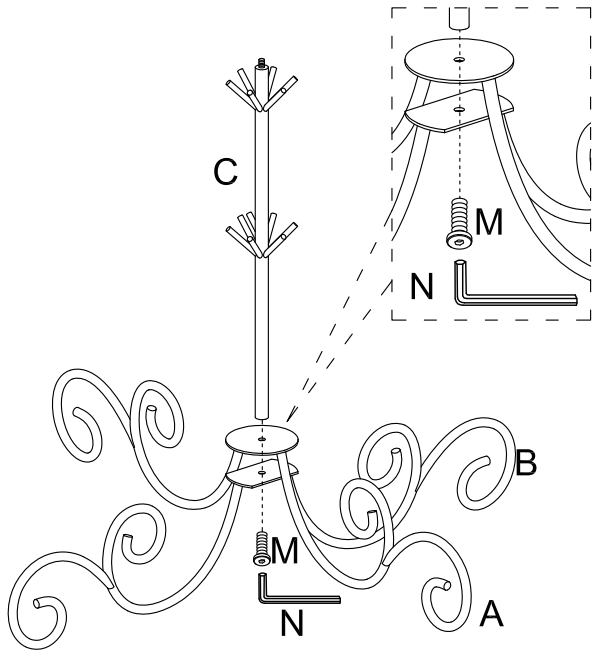

Step 2

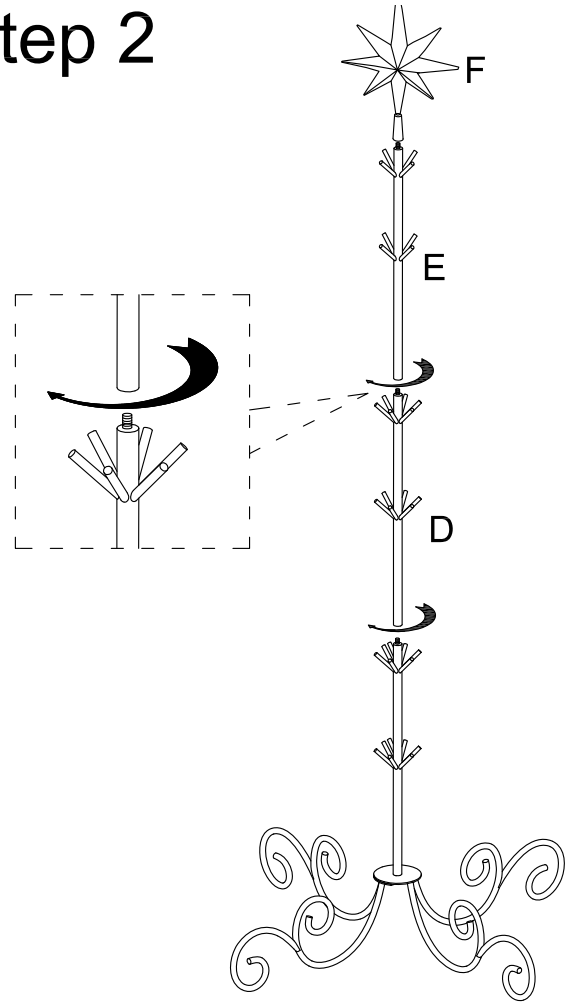

Step 3

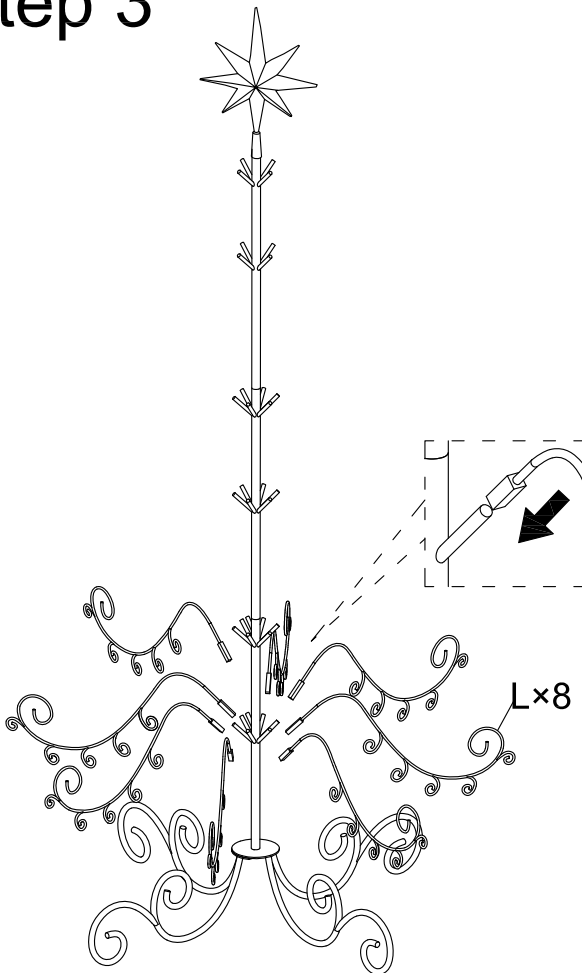

Step 4

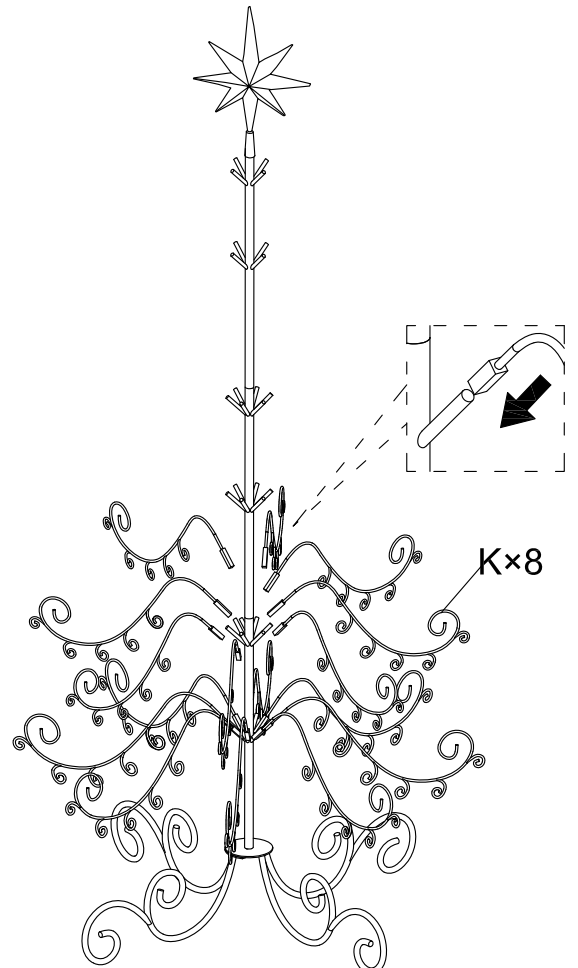

ASSEMBLY

Step 5

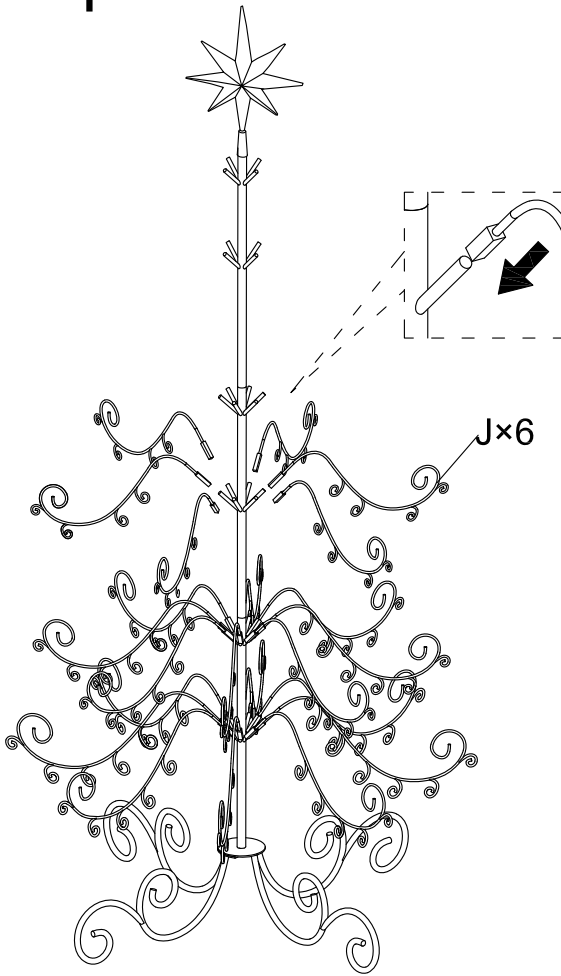

Step 6

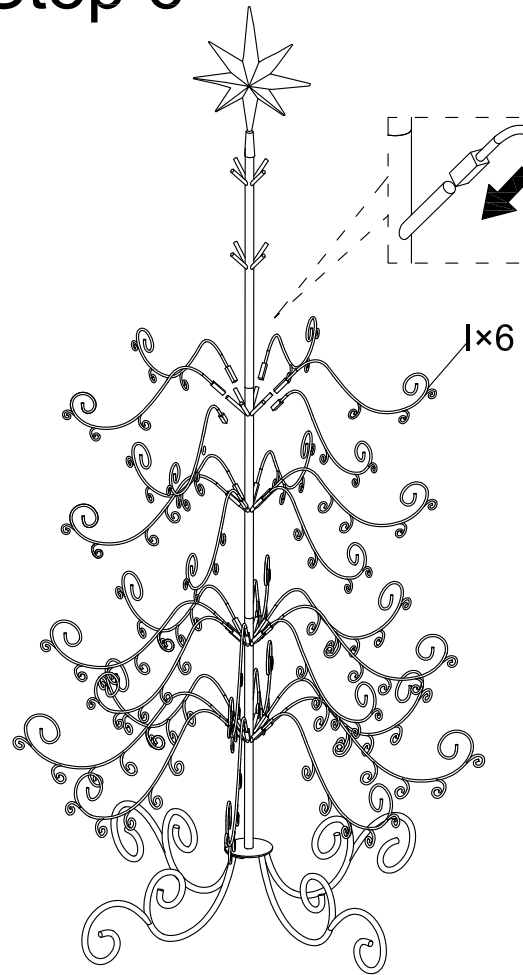

Step 7

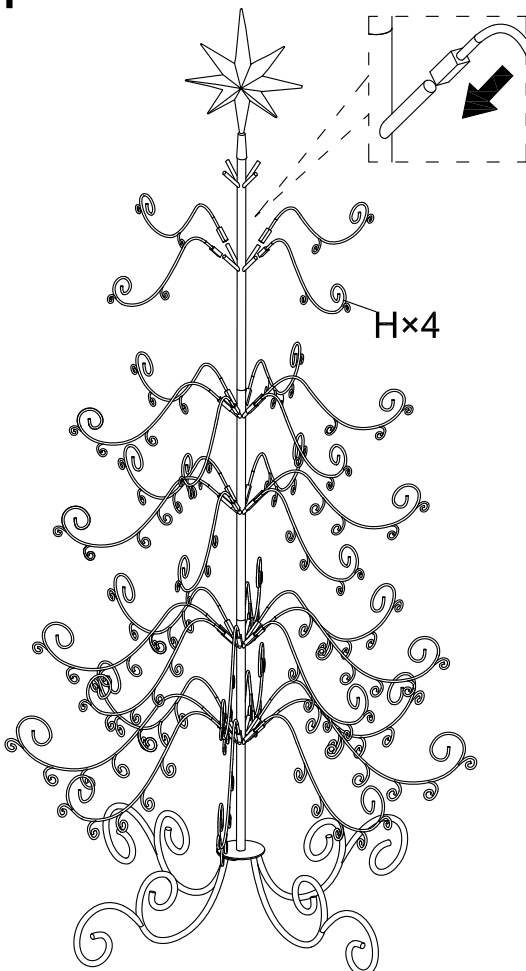

Step 8

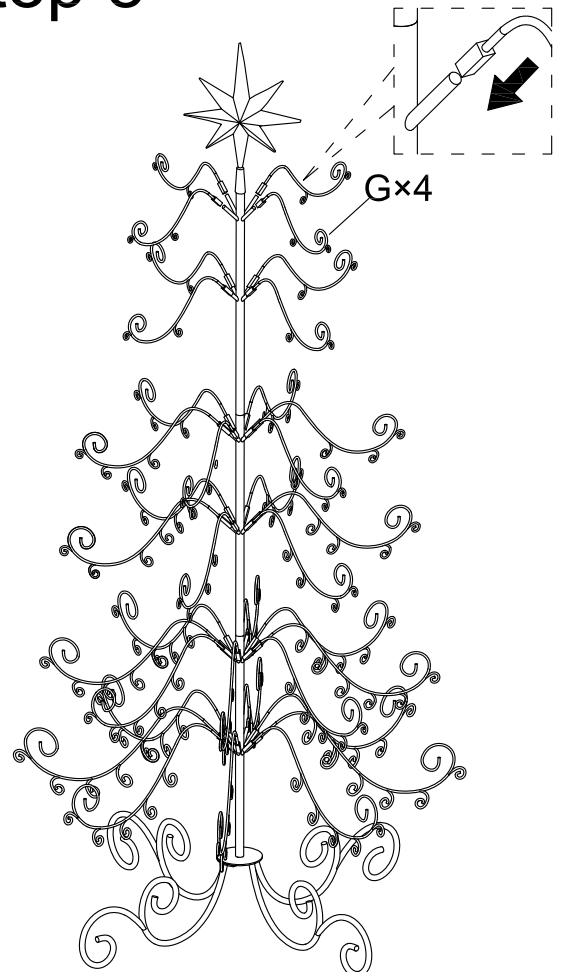

DISCLAIMER

PLEASE READ THE FOLLOWING CAREFULLY

THE MANUFACTURER AND/OR DISTRIBUTOR HAS PROVIDED THE PARTS LIST AND ASSEMBLY DIAGRAM IN THIS MANUAL AS A REFERENCE TOOL ONLY. NEITHER THE MANUFACTURER OR DISTRIBUTOR MAKES ANY REPRESENTATION OR WARRANTY OF ANY KIND TO THE BUYER THAT HE OR SHE IS QUALIFIED TO MAKE ANY REPAIRS TO THE PRODUCT, OR THAT HE OR SHE IS QUALIFIED TO REPLACE ANY PARTS OF THE PRODUCT. IN FACT, THE MANUFACTURER AND/OR DISTRIBUTOR EXPRESSLY STATES THAT ALL REPAIRS AND PARTS REPLACEMENTS SHOULD BE UNDERTAKEN BY CERTIFIED AND LICENSED TECHNICIANS, AND NOT BY THE BUYER. THE BUYER ASSUMES ALL RISK AND LIABILITY ARISING OUT OF HIS OR HER REPAIRS TO THE ORIGINAL PRODUCT OR REPLACEMENT PARTS THERETO, OR ARISING OUT OF HIS OR HER INSTALLATION OF REPLACEMENT PARTS THERETO.

Record Product's Serial Number Here: _____

Note: If product has no serial number, record month and year of purchase instead.

Note: Some parts are listed and shown for illustration purposes only and are not available individually as replacement parts.

The material in this manual is for informational purposes only. The product(s) it describes are subject to change without prior notice, due to the manufacturer's continuous development program. XtremePowerUS makes no representations or warranties with respect to this manual or with respect to the products described herein. XtremePowerUS shall not be liable for any damages, losses, costs or expenses, direct, indirect or incidental, consequential or special, arising out of, or related to the use of this material or the products described herein.

Questions, issues or missing parts?

Before returning to your retailer, our customer service team is here to help.



Call Us: 909.628.0880

Email Us: customer@bartonliving.com

Hours of Operation: 9am - 3pm PST Monday - Friday